

The Logic Systems Ci115 is a compact, high power, bass enclosure which features a direct radiating 15" bass driver. The Ci115 is installation specific. Corner porting also ensures uniformity of performance when mounted in either the landscape or portrait modes.

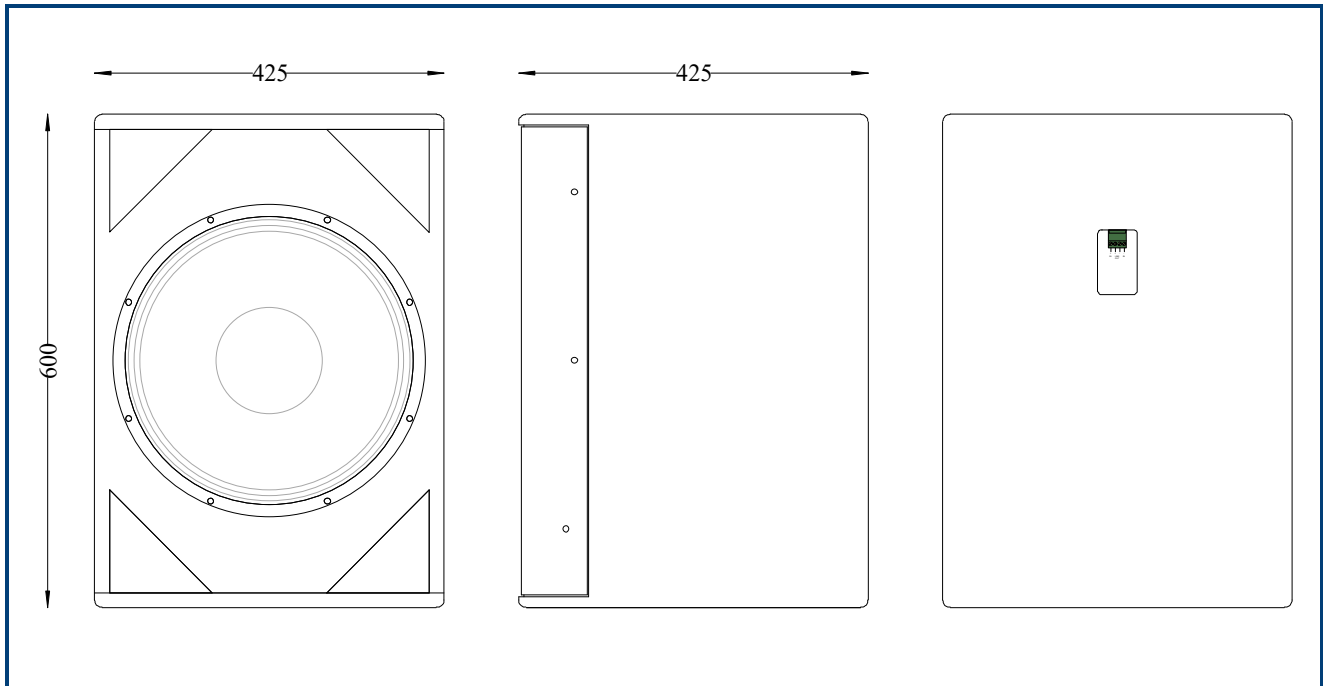

Frequency Response:	<ul style="list-style-type: none"> • 40Hz - 150Hz
Components:	<ul style="list-style-type: none"> • Bass: 1 x 15" cone driver • HF: N/A
Power handling:	<ul style="list-style-type: none"> • 600w
Sensitivity (1):	<ul style="list-style-type: none"> • 99dB
Directivity:	<ul style="list-style-type: none"> • Omni-directional
Impedance:	<ul style="list-style-type: none"> • 8 Ohm
Construction:	<ul style="list-style-type: none"> • 18mm Birch plywood
Finish:	<ul style="list-style-type: none"> • Water based textured black paint
Connections:	<ul style="list-style-type: none"> • Phoenix screw terminal connector (supplied)
Dimensions:	<ul style="list-style-type: none"> • 425mm (W) x 600mm (H) x 425mm (D)
Packaged Dimensions:	<ul style="list-style-type: none"> • 560mm (W) x 750mm (H) x 560mm(D)
Weight:	<ul style="list-style-type: none"> • 25Kg

Cabinet	Handles	Tophat	M20	Castors	Bracket Pt.	Inserts/Fly Points
Ci115	No	No	No	No	No	No

Note: (1) Sensitivity measured at 1 metre with 2.83V, using band limited pink noise.